

INSTALLATION INSTRUCTIONS

Troldtekt® Plus K0, K5, K11 and K0-U, installed with screws

These instructions apply to installation of Troldtekt® Plus K0, K5, K11 and K0-U with screws on wooden battens or steel profile system.

If you install Troldtekt® on wooden battens, the battens should be minimum 22x95 mm.

You can download installation instructions for the Troldtekt® C60 profile system or wooden battens from www.troldtekt.com.

PROFILE DRAWINGS (INDEPENDENT OF SUSPENSION)

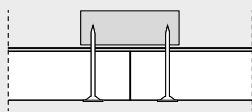

K0 Troldtekt Plus 25
Square edges

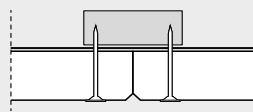

K5 Troldtekt Plus 25
With 5 mm bevel

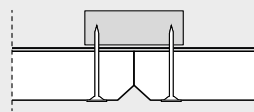

K11 Troldtekt Plus 25
With 11 mm bevel

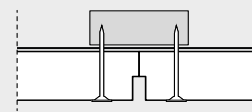

K0-U Troldtekt Plus 25
Square edges and U-trace

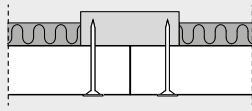

K0 Troldtekt Plus
Square edges

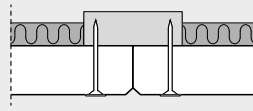

K5 Troldtekt Plus
With 5 mm bevel

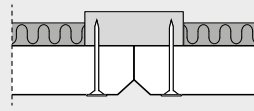

K11 Troldtekt Plus
With 11 mm bevel

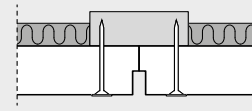

K0-U Troldtekt Plus
Square edges and U-trace

PANEL THICKNESS

Troldtekt Plus 25 is available in the following thickness:

25 mm

Troldtekt Plus is available in the following thicknesses:

25+20 / 25+40 / 35+20 / 35+40 mm

(**Note:** 25+40 / 35+40 mm cannot be combined with a C60 profile system)

INSTALLATION (PLEASE READ FULL INSTRUCTIONS BEFORE STARTING WORK)

1: Start by installing a complete row of Troldtekt panels along the centre line of the room. Then continue on both sides. It is important that the panels are installed closely together, and the optimum aesthetic effect is obtained by installing the panels in broken bond.

2: Fix the panels using Troldtekt screws spaced 25/20 mm from the edges – as indicated in the figure below. 25 mm for wooden battens, 20 mm for C60 steel profiles. Be careful not to overdrive the washered screws and so cause an indentation in the panel.

Note: When installing **600x600 mm** square panels, it is important to ensure that the wood wool fibres run mainly parallel in one direction. To ensure a uniform appearance, install the panels so that the printed Troldtekt texts on the back of the panels all run in the same direction.

ILLUSTRATION – INSTALLATION, K0, K5, K11 AND K0-U

The figure shows longitudinal wooden battens, but transverse battens are equally applicable. Note, however, the tolerances of the Trolldtekt panels. If the panels are very dry, they could be undersized, which could cause problems on very large surfaces with transversal wooden battens.

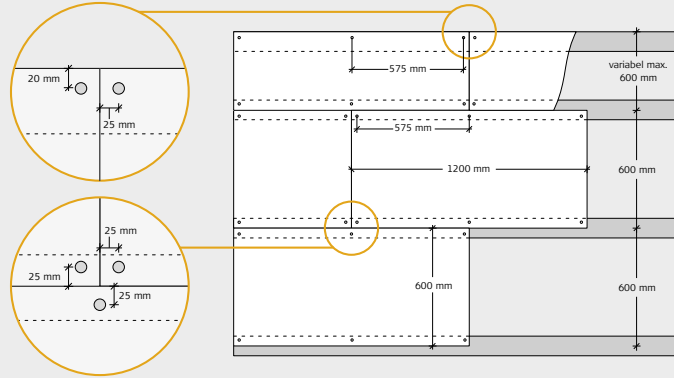

VAPOUR CHECK

If you need to install a vapour check, we recommend using polyethylene. The vapour check must be placed over the wooden battens, i.e. between the battens and the main beam. Install the vapour check tightly against the insulation.

Please refer to the manufacturer's instructions.

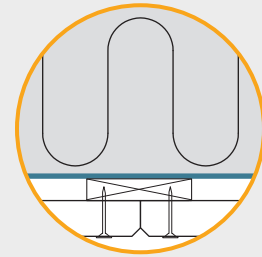

TROLDTEKT® SCREWS

Panel thickness (mm)	Panel length (mm)	Screw dimension (mm)	No. of screws (per panel)	Max. span (mm)
25 / 25+20 / 25+40	600	4.2x45/4.2x50	4	600
	1200		6	
	2000/2400		10	
35 / 35+20 / 35+40	600	4.2x55/4.2x50	4	600
	1200		6	
	2000/2400		10	

Trolldtekt structure screw for wood and steel, PH 2
4.2 x 45 mm / 4.2 x 55 mm



Trolldtekt structure screw for steel, PH 2
4.2 x 50 mm



This document reflects Trolldtekt's knowledge of certifications, standards, and products at the time of publication. No rights can be derived from this document. Changes, typesetting and printing errors reserved.

The most recent version can be found online by scanning the QR code.

JANUARY 2025 UK IE V01

Trolldtekt Limited
Pembroke
Leominster

Herefordshire
HR6 9LA
United Kingdom

Tel +44 7555 176055
sales@trolldtekt.co.uk

www.trolldtekt.co.uk